

3 PIECES BALL VALVE

Stainless Steel, Flanged

Design

Size : DIN 3202
 Connection : DIN 2633
 Actuator Connection : ISO 5211

Technical Features

Working Pressure : PN16
 Working Temperature : -30°C / +180°C
 Usage : Water, oil, gas



NO	PART NAME	MATERIAL
1	Body	CF8/M
2	End Cap	CF8/M
3	Ball	304/316
4	Stem	304/316
5	Seat	PTFE
6	Gasket	PTFE
7	Thrust Washer	PTFE
8	Stem o-ring	VITON
9	Packing	PTFE
10	Metal Ring	304
11	Belleville Washer	304
12	Gland	CF8/M
13	Stop Plate	304
14	Nut	304
15	Inner six angle	304
16	screw	CF8
17	Handle	304
18	Bolt	304
19	Nut	304
20	Bolt	304

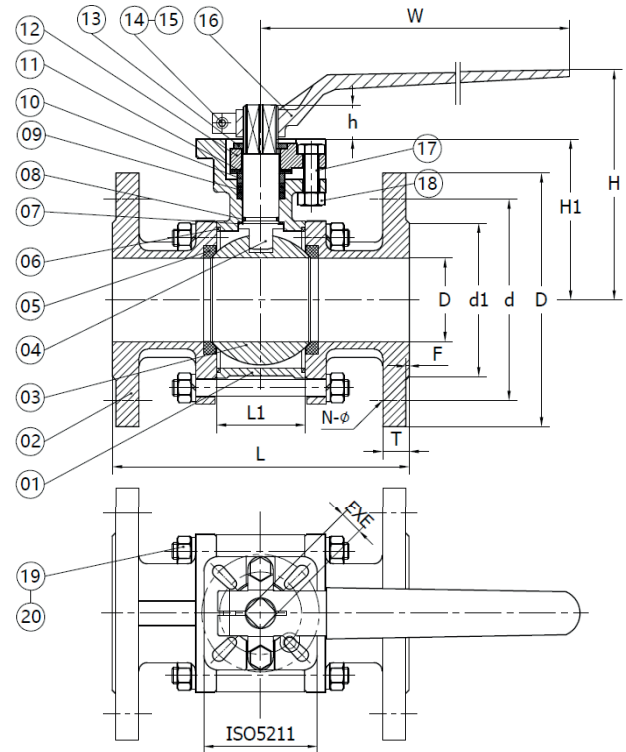

SIZE	DN	L	L1	W	D	d	d2	T	F	N-Q	H	H1	h	E	ISO5211
1/2	15	130	28	110	95	65	45	15	2	4-14	76	48.5	8	9	F04/F05
3/4	20	150	32	110	105	75	58	17	2	4-14	81	53.5	8	9	F04/F05
1	25	160	38	160	115	85	68	17	2	4-14	90	59	10	11	F04/F05
1 1/4	32	180	50	160	140	100	78	18	2	4-18	102	71	10	11	F04/F05
1 1/2	40	200	54	185	150	110	88	18	3	4-18	114	78	14	14	F05/F07
2	50	230	68	185	165	125	102	20	3	4-18	118	85	14	14	F05/F07
2 1/2	65	290	85	305	185	145	122	22	3	8-18	168	98	16	17	F07/F10
3	80	310	99	305	200	160	138	24	3	8-18	178	110	16	17	F07/F10
4	100	350	130	305	235	190	162	24	3	8-22	198	130	18	19	F07/F10